

Uncompromised micro
print quality for more
content in less space

Continuous Inkjet

Videojet® 1620 and 1650 High Resolution Micro Printers

 **VIDEOJET**

Videojet High Resolution Continuous Inkjet for micro print applications



When print size is everything and clarity is critical, the Videojet High Resolution (HR) inkjet is built to perform. By delivering uncompromised quality down to the smallest 0.6mm (1/32") print height and speeds of up to 348m/min (1,142fpm), the printer helps guarantee legible codes on even the smallest print areas. Capable of printing up to three lines of print, 2D and linear bar codes, our HR micro printers address demands for more content in less space.

Available in two options; the 1650 HR features our exclusive CLARiTY™ touchscreen interface offering built-in productivity tools to boost OEE. The 1620 HR offers a simple keypad interface that is robust and easy to use.

Uptime Advantage

- CleanFlow™ technology together, with auto-cleaning printhead, delivers up to 300 hours of operation between printhead cleanings.
- 14,000 hours of run time between planned printer maintenance
- Dynamic Calibration™ adjusts jetting parameters automatically for optimal print quality

Built-in productivity

- High speed printing of quality codes up to 348m/min (for single line alphanumeric code)
- On-board access to standard OEE metrics backed by actionable data*
- Recover faster with CLARiTY™ interface one touch fault information*

Code Assurance

- High resolution nozzle helps ensure industry's smallest print down to 0.6mm text height
- Precision Ink Drop™ technology provides precise character formation
- CLARiTY™ based user interface helps prevent costly coding mistakes*

Simple usability

- Modular service core and printhead design make wear parts replacements quick and easy
- Smart Cartridge™ fluid delivery system eliminates mess and ensures correct fluids are used
- Large, responsive 10.4" touchscreen is easy to operate and visible from a distance*

*Available on 1650 HR model only

Advanced Inks for special requirements

Videjet Ink chemists have formulated halogen-free electronics inks to meet stringent standards expected in this industry, while fast drying and other specialist inks provide durability for abrasion, temperature and chemical resistance.

All HR inks can be used on RoHS compliant products (EC 2011/65/EU Annex II) suiting a host of applications including printing on heat sinks, capacitors, connectors and high insulation tapes.

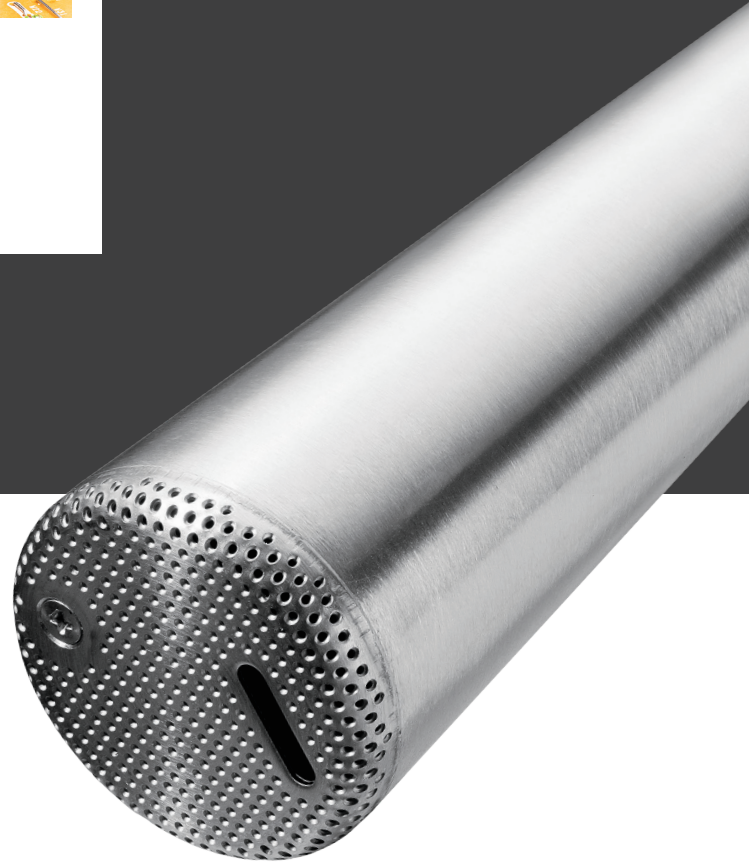
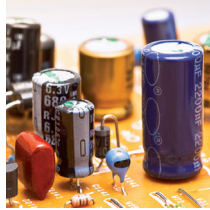

CleanFlow™ technology reduces ink build-up and cleanings

Micro print nozzle innovation

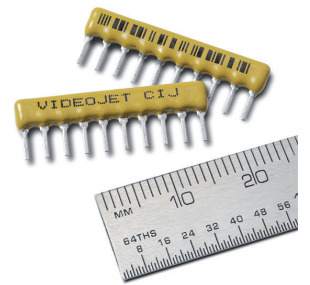
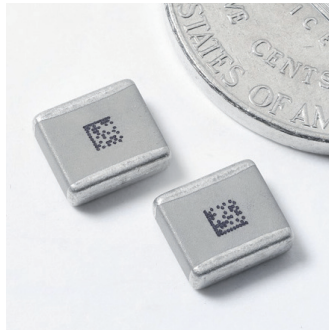





Our new HR printers feature Videjet Precision Ink Drop™ technology which allows the nozzle to operate at over 100,000 drops per second via the advanced high frequency printhead design. Together with sophisticated software algorithms, this technology modifies the flight path of individual ink drops for optimal code quality.

These printhead enhancements, plus specialized rasters, overcome the print quality challenges inherent in shortened character heights and fast line speeds.

The HR micro printer can print more data with better legibility, at faster line speeds, often in the same, limited print area when compared to traditional micro printing systems.

CleanFlow™ technology reduces ink build-up on nozzle ends, enabling printers to run longer between cleaning intervals.

High resolution micro print sample guide

Description	Print sample
Single line 4x5	ABCDEFG abcdefg 12345 4X5 SINGLE LINE
Single line 5x5	ABCDEFG abcdefg 12345 5X5 SINGLE LINE
Single line 5x7	ABCDEFG abcdefg 12345 5X7 SINGLE LINE
Single line 7x9	ABCDEFG abcdefg 12345 7X9 SINGLE LINE
Single line 10x16	ABCDEFG abcdefg 12345 10X16 SINGLE LINE
Single line 16x24	ABCDEFG abcdefg 12345 16X24 SINGLE LINE
Twin line 5x5	ABCDEFGHIJKLMN OP 1234567890 5X5 TL
Twin line 5x7	ABCDEFGHIJKLMN OP 1234567890 5X7 TL
Three line 5x5	ABCDEFGHIJKL MN OP 1234567890 5X5 TRI LINE
16x24 with bar code	 24HIGH
All fonts, all heights	5 DOTS HIGH 7 DOTS HIGH 9 DOTS HIGH 16 DOTS HIGH 24 DOTS HIGH
Inverted/reversed characters Accommodates product lines going any direction and products in various orientations on the production line	INVERTED TEXT TEXT REVERSE
2D DataMatrix Wide range of standard 2D and rectangular 2D DataMatrix, including GS1	 QR CODE  24HIGH  2D DATAMATRIX
Horizontal DPI comparison (180, 90, 60)	VJ1620HR VJ1650HR HIGH RESOLUTION
Unique-character languages	ج ت ث ب ا 合格年月日期生产保质 アカサタナハマヤラフ Arabic Chinese Japanese
Graphics and logos	   RECYCLE

All images printed at 90dpi with the exception of the dpi comparison samples

Videojet® 1620 and 1650 High Resolution

Continuous Inkjet micro printers

Line speed capability

Can print 1 to 3 lines of print at speeds of up to:
Single line max speed = 348 m/min (1142ft/min)
Dual line max speed = 124 m/min (408 ft/min)
Tri-line max speed = 72 m/min (235 ft/min)
(15 characters per inch, single line of print)

Font matrix configuration

Single-line: 4x5, 5x5, 4x7, 5x7, 7x9, 9x12, 10x16, 16x24
Twin-line: 4x5, 5x5, 4x7, 5x7, 7x9
Tri-line: 4x5, 5x5, 4x7, 5x7, 24 Drop Mixed Raster

Linear bar codes

UPC A&E; EAN 8 & 13; Code 128 A, B & C; UCC/EAN 128;
Code 39; Interleaved 2 of 5; 2D DataMatrix; GS1; QR Code

DataMatrix codes

Square Form up to 24x24; Rectangular Form up to 16x48

Nominal character height

Selectable from 0.6mm to 7mm (0.024" - 0.276"), depending on font

Throw distance

Optimal: 6mm (0.236")
Range: 2mm to 12mm (0.079" to 0.472")

User interface options:

1. CLARiTY™ 10.4" high-response TFT-LCD touch screen (available with 1650 HR)
 2. 320x240 bright blue backlit 5.7" LCD display (available with 1620 HR)
- Both offer WYSIWYG onscreen message editing

Custom logo/graphics

Can be created by individual user on printer or PC with optional Videojet Logo Creator software

Character sets

Chinese, Russian/Bulgarian, Turkish/Scandinavian, Greek, Arabic, Japanese/Kanji, Hebrew, Korean, East European and European/American

Languages and interface options

English, Arabic, Bulgarian, Czech, Danish, Dutch, Finnish, French, German, Greek, Hebrew, Hungarian, Italian, Japanese, Korean, Norwegian, Polish, Portuguese, Russian, Simple Chinese, Spanish, Swedish, Thai, Traditional Chinese, Turkish and Vietnamese
All languages available with 1650 HR only

Data interface

RS232, RS485 and ethernet (standard)
CLARiSOFT™/CLARiNET™ via RS232 and ethernet
Message management via USB

Message storage

250 complex messages (250+ on 1650 HR model)

Environmental protection

IP65 standard; no plant air required; stainless steel cabinet

Printhead

Heated printhead
Positive air (standard)
Nozzle size: 40 micron
Diameter: 41.3 mm (1.63")
Length: 269.8 mm (10.62")

Printhead umbilical

Ultra flexible
Length: 3 m (9.84') optional 6m (19.69')
Diameter: 21 mm (0.83")
Bend radius: 101.6 mm (4.0")

Make-up fluid consumption

As low as 2.4 ml/hour

Fluids containers

Ink Smart Cartridge™ 750 ml (0.793 qt.)
Make-up Smart Cartridge™ 750 ml (0.793 qt.)
Ink bulk system 5 liters (5.28 qts.)**
Make-up bulk system 5 liters (5.28 qts.)**

Temperature/humidity range

5°C to 45°C (41°F to 113°F)
0% to 90% RH non-condensing
With selected inks, actual installation may require additional hardware based on production environment conditions

Electrical requirements

Nominal supply power 100-120 / 200-240 VAC at 50/60 Hz.,
120W peak maximum, 60W nominal

Approximate weight

Unpacked and dry: 21 kg (46.2 lbs).

Options

Dry air kit for high humidity (requires plant air)
Wide range of accessories

** Optional; 1650 HR only

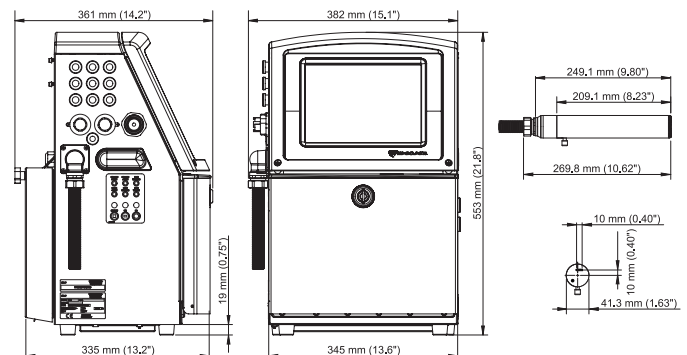

Peace of mind comes as standard

Videojet Technologies is a world-leader in the product identification market, providing in-line printing, coding, and marking products, application specific fluids, and product life cycle services.

Our goal is to partner with our customers in the consumer packaged goods, pharmaceutical, and industrial goods industries to improve their productivity, to protect and grow their brands, and to stay ahead of industry trends and regulations. With our customer application experts and technology leadership in Continuous Inkjet (CIJ), Thermal Inkjet (TIJ), Laser Marking, Thermal Transfer Overprinting (TTO), case coding and labeling, and wide array printing, Videojet has more than 325,000 printers installed worldwide.

Our customers rely on Videojet products to print on over ten billion products daily. Customer sales, application, service and training support is provided by direct operations with over 3,000 team members in 26 countries worldwide. In addition, Videojet's distribution network includes more than 400 distributors and OEMs, serving 135 countries.

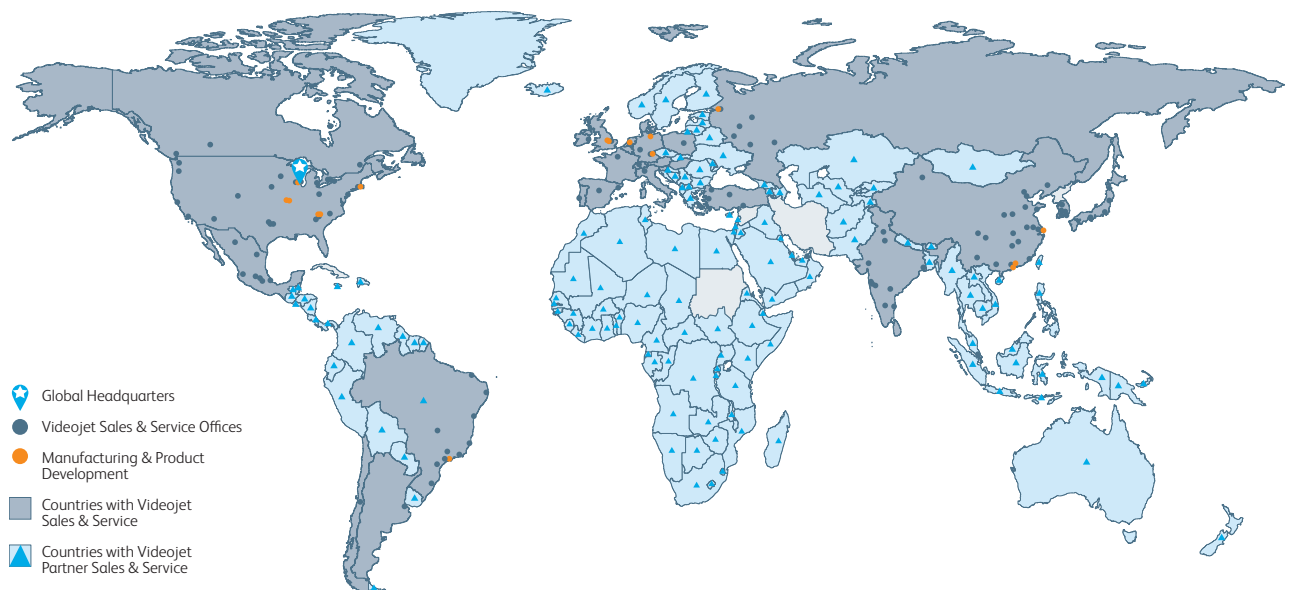

Call **800-843-3610**
Email **info@videojet.com**
or visit **www.videojet.com**

Videojet Technologies Inc.
1500 Mittel Blvd. Wood Dale IL 60191 / USA

©2015 Videojet Technologies Inc. — All rights reserved.
Videojet Technologies Inc.'s policy is one of continued product improvement.
We reserve the right to alter design and/or specifications without notice.
Printed in U.S.A.

Mark-Line Systems OÜ
Läike tee7, Peetri, Rae vald
75312, Harjumaa
Tel +3726235575
info@markline.ee

