



Reduce unplanned  
downtime, waste,  
and rework

Home	
JOB	20239015
Performance	1kg Carrots MP
Throughput	
Batch Count	41 p/m
iAssurance	1729
	99.8%

Thermal Transfer Overprinting

# Videojet DataFlex® 6530 & 6330



As a world leader in the coding industry, Videojet has researched, designed, and developed a series of enhanced Thermal Transfer Overprinting products that can answer your demanding requirements.



# Introducing the next generation of Videojet DataFlex® Thermal Transfer Overprinting products

The 6530 and 6330 are part of the Videojet DataFlex® range of Thermal Transfer Overprinters (TTO), which are designed to give you a more productive operation. These new Videojet printers embody the latest technology to further improve uptime while reducing time spent on quality checks, waste, and rework to drive productivity, quality and efficiency.

## Uptime Advantage

- Reduce costs and downtime, maximize printhead life and gain consistent print quality thanks to airless Videojet Intelligent Motion™ technology
- Up to 1,200m ribbon capacity and a variety of ribbon economy modes help maximize the time between ribbon changeovers

## Code Assurance

- Videojet iAssure™ technology\*, a built-in code quality checker, helps reduce waste and rework with no additional hardware, installation or training
- Videojet CLARiTY™ software helps ensure the right code is consistently printed on the right product

## Easy Usability

- Simple operator interface
- Designed to withstand tough production line environments
- Minimal wear parts are easy to change out, improving production line uptime

## Built-in Productivity

- Using default settings you can maintain consistent code quality and avoid conventional air and energy settings that operators might over-adjust
- Quickly discover code legibility issues that indicate the potential need for printer maintenance
- Industry-leading simple cassette change designed for fast ribbon replacement to maximize uptime
- 25% faster throughput than previous Videojet TTO models



\* iAssure not available in 107mm printhead width

# Videojet DataFlex® 6530 & 6330

Videojet DataFlex® Thermal Transfer Overprinters are designed to withstand tough production line environments. With minimal wear parts, airless, all-electronic design, and quick change ribbon cassette, the enhanced Dataflex 6530 and 6330 TTO line offers maximized uptime advantage and integration flexibility.



## Videojet DataFlex® 6530 (107mm)

The Dataflex 6530 107mm is the first airless 107mm TTO, eliminating the need for expensive compressed air, and avoiding conventional air and energy settings that operators might over-adjust.

The Dataflex 6530 107mm is designed to be compact and modular, and fits onto almost all production lines. Up to 1,200m ribbon capacity and a variety of ribbon economy modes maximizes the time between ribbon changeovers, improving uptime.



## Videojet DataFlex® 6530 (53mm)

The DataFlex 6530 53mm features Videojet iAssure™ technology, a built-in code quality checker that helps reduce waste and rework with no additional hardware, installation or training.

The Dataflex 6530 53mm is a high speed TTO, and offers print speeds of up to 1000mm/s and throughputs up to 700 ppm.\*

\* Application and substrate dependent. iAssure™ technology is not currently supported for use with all ribbon savings modes.

**The DataFlex 6530 107mm  
is the first airless 107mm  
TTO printhead in the market**

Reduce costs and downtime,  
maximize printhead life and gain  
consistent print quality thanks  
to airless Videojet Intelligent  
Motion™ technology



## Videojet DataFlex® 6330 (32mm and 53mm)

The DataFlex® 6330 is a mid-range TTO that features Videojet iAssure™ technology.

In addition, airless Videojet Intelligent Motion™ technology helps to reduce costs and downtime, maximize printhead life and gain consistent print quality.

The 6330 helps to tackle coding errors, improve Overall Equipment Effectiveness (OEE) and reduce unwanted waste or reworked product, and offers print speeds of up to 750mm/s and throughputs up to 250 ppm.\*

Our products are widely used throughout the snack food, bakery and confectionery markets, and demonstrate excellent performance in the frozen and refrigerated foods, meat and poultry, cosmetics, pharmaceutical and nutraceuticals industries.

As a result of understanding your world, we have been able to design Thermal Transfer Overprinters that integrate seamlessly with your packaging machinery.



# Reduce waste & rework with iAssure™ built-in code quality checker

## How iAssure™ works

iAssure™ technology continually checks for print defects by taking a picture of every single code, assessing the quality, and if chosen limits are exceeded, rejecting the code or stopping the line. iAssure™ technology is exclusively built into the Dataflex 6530 53mm and the 6330.



### 1 Image capture

Built-in sensors create a perfect image of the printed TTO ribbon as it indexes to the next print.

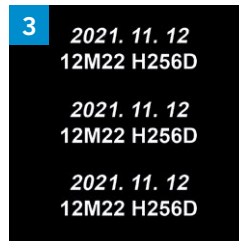

### 3 Image comparison

The code quality and presence is evaluated with a pass/fail decision.

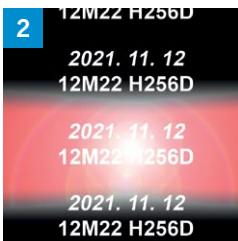

### 2 Image analysis

Each image is processed in real-time and assessed for quality and presence.



### 4 Fault trigger event

If a pre-set number of codes fail, the printer triggers a fault that stops the line or sends product into a reject or inspection area.

Not actual codes, for illustration purpose only

iAssure™ intelligent technology checks code quality and presence with no additional hardware, installation or training costs.

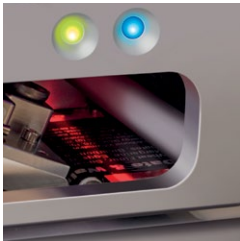
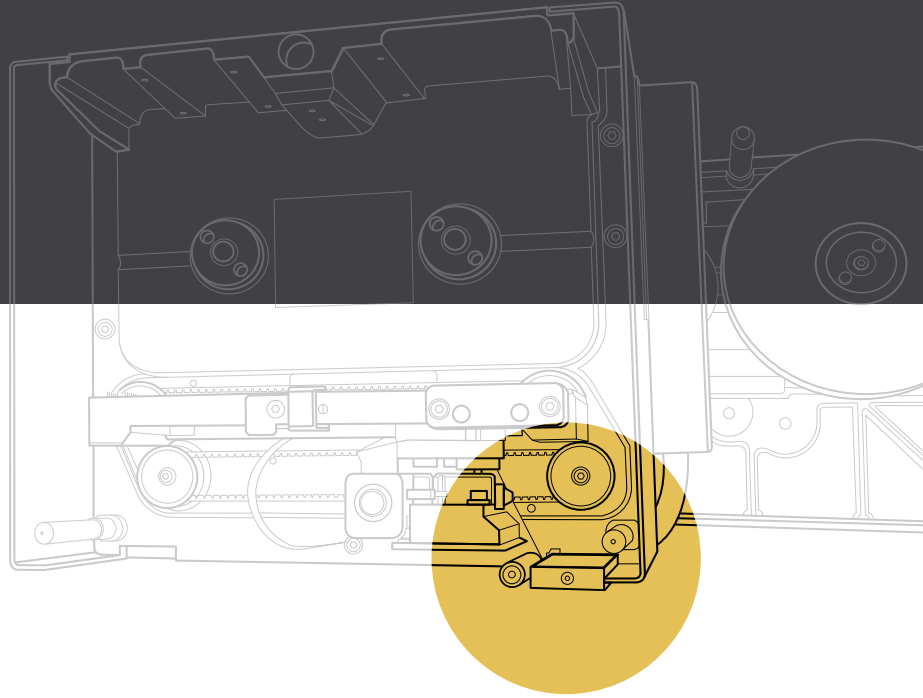

**iAssure™  
imaging system**

Unit cutaway for display purposes only

## Code quality assurance

With Videojet iAssure™ technology, alphanumeric code defects like these are automatically identified when the codes are checked for legibility.

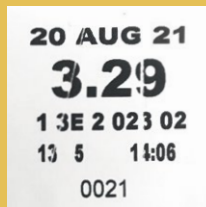

Ribbon crease due to damaged cassette

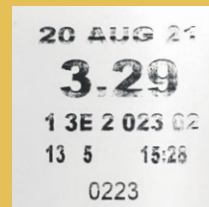

Worn print surface degrades quality

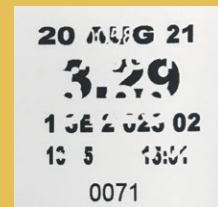

Overprint from pre-run ribbon

**iAssure™ technology brings confidence back to the line**

# Intelligent design

The modular design of the Dataflex 6530 and 6330 helps customers in a number of ways:

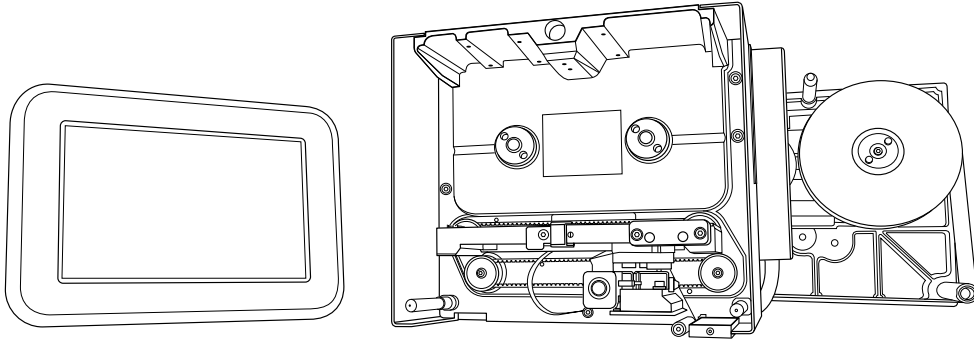

## Modularity

The Dataflex 6530 & 6330 have been designed to be compact and modular, allowing manufacturers and OEMs the flexibility in how they choose to integrate the printer.

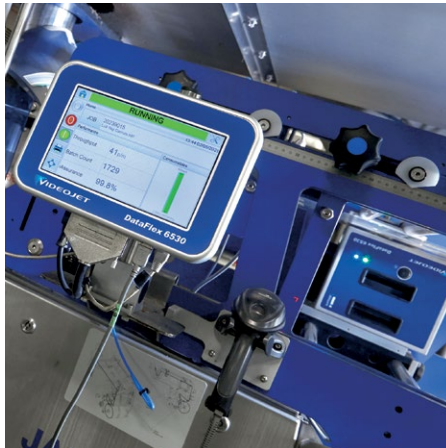

## Easy integration

The Dataflex 6530 & 6330 are easy to integrate into most production lines, and include industry standard mounting features to help simplify installation and improve operator accessibility and interaction.

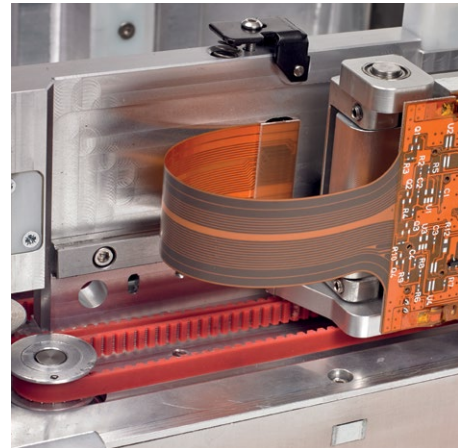

## Airless

The airless, all-electronic operation eliminates expensive compressed air requirements, and helps the printer to run more efficiently.

Removing the need for air hoses and associated wear parts reduces the need for operator interaction.





### Intuitive user interface

An intuitive tablet-like 5" touchscreen controller is simple to use and reduces the number of operator touches, helping to reduce operator errors.

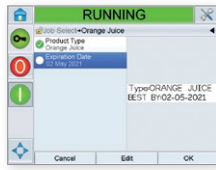

### CLARiTY™

CLARiTY™ software helps ensure the right code is consistently printed on the right product, reducing the potential for print and coding errors, as well as waste and rework with no extra manpower or equipment.



### Simple cassette

An industry leading quick change cassette is designed to deliver both excellent ribbon efficiency and fast ribbon replacement, helping to maximize production uptime. Up to 1,200m ribbon capacity ribbon capacity and a variety of ribbon economy modes help maximize the time between ribbon changeovers.



### Challenging applications

Additional features for challenging zipper applications and uneven film surfaces gives manufacturers more choice and flexibility in using the printer with increasingly complex package designs.



### Intelligent Motion™

### Intelligent Motion™

Intelligent Motion™ technology removes the need for compressed air, as well as associated costs and downtime, maximizing printhead life and consistent print quality.



### VideojetConnect™

### VideojetConnect™

VideojetConnect™ is part of our cloud-based software offering, and is a scalable solution that can give you transparency into your packaging line operation, empowering you to maximize production throughput and reduce operating costs.

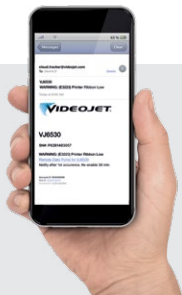

### VideojetConnect™ Remote Service

With optional VideojetConnect™ Remote Service\*, your team can access Videojet experts to help improve productivity and troubleshoot potential issues in ways that other printers can't.



### Remote Alerts: Be the 1st to know

Real-time notification of printer needs, warning or fault conditions.



### Dashboards: Be the 1st to respond

Instant visibility to valuable printer activity.



### Remote Recovery: Be the 1st to recover

With remote recovery, Videojet expertise is virtually a click away.

\* Subject to availability in your country

# Intelligent application

The Dataflex 6530 and 6330 Thermal Transfer Overprinters are ideal for flexible packaging applications. When coding applications require content to be printed on products to meet regulatory demands, such as ingredient lists, nutrition statements, traceability information, or use-by dates, our CLARiTY™ software helps to ensure that the right information is printed on the right package, time after time.

TTO printers have traditionally been able to print glossy labels and flexible film packages. The Dataflex 6530 and 6330 printers now print on newer flexible film package types like resealable pouches, stick packs and sachets, offering customers more choice about how they want to package and code their products.

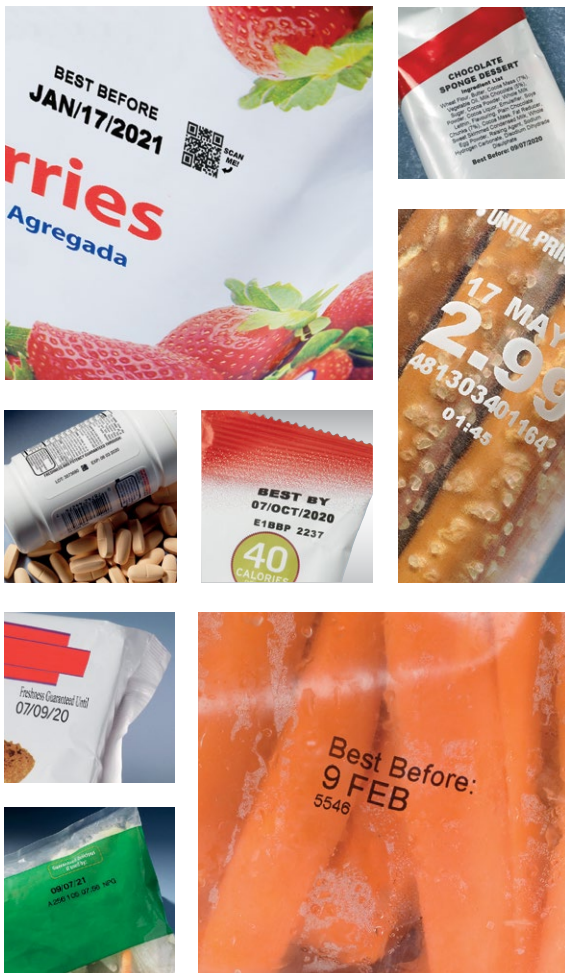

# Intelligent maintenance

The Dataflex 6530 and 6330 feature an easy-to-use cassette design, which fits ribbon lengths of up to 1,200m. Simple ribbon path ensures fast changeovers and a more efficient operation, therefore reducing downtime.



Limited wear components are fast and easy to change to help ensure that manufacturers are up and running as quickly as possible. The new printhead design is simple to replace and requires no additional operator intervention to return to printing.



On-board videos guide operators through routine maintenance and operator tasks including printhead cleaning and replacement.

# Overview



Specification	6530		6330	
	53mm	107mm	53mm	32mm
Printer Mode	Intermittent and Continuous Motion			
Print Gap	Consistent 0.020" (0.5mm)			
Ribbon Widths	0.8" (20mm), 2.2" (55mm) max	2.2" (55mm), 4.33" (110mm) max	0.8" (20mm), 2.2" (55mm) max	0.8" (20mm), 1.3" (33mm) max
iAssure Enabled	Yes	No	Yes	Yes
Bar Code Printing	EAN 8, EAN 13, UPC-A, UPC-E, Code 39, EAN 128, Code 128, ITF, RSS (including 2D composite codes); others may be available upon request			
Operator Interface	TFT SVGA 800x480 full-color LCD and touch screen, WYSIWYG print preview, full on-board diagnostics, 3 levels of password protection, extensive language support			
Master/Follower Capability (Up to 4 Printers Controlled by One User Interface)	Up to four Videojet DataFlex® 6530 printers controlled via a single CLARiTY™ control unit	Up to four Videojet DataFlex® 6530 printers controlled via a single CLARiTY™ control unit	Up to four Videojet DataFlex® 6330 printers controlled via a single CLARiTY™ control unit	Up to four Videojet DataFlex® 6330 printers controlled via a single CLARiTY™ control unit
Standard Communication	RS232, dual Ethernet, USB memory stick and scanner support, Binary and ASCII comms protocols, Windows® drivers, ZPL and SATO emulations			
Web Browser Capability	Yes			

## Continuous mode:

Maximum Print Area (Width x Length)	2.1" (53mm) wide x 11.8" (300mm) long	4.3" (107mm) wide x 11.8" (300mm) long	2.1" (53mm) wide x 7.9" (200mm) long	1.3" (32mm) wide x 7.9" (200mm) long
Maximum Print Speed	39.4 in/sec (1,000mm/sec)	39.4 in/sec (1,000mm/sec)	29.5 in/sec (750mm/sec)	29.5 in/sec (750mm/sec)
Minimum Print Speed	0.04 in/sec (1mm/sec)	0.04 in/sec (1mm/sec)	1.6 in/sec (40mm/sec) full print quality; 0.4 in/sec (10mm/sec) draft mode print quality	1.6 in/sec (40mm/sec) full print quality; 0.4 in/sec (10mm/sec) draft mode print quality
Estimated Maximum Throughput (Single Line Code)	Up to 700 prints per minute	Up to 450 prints per minute	Up to 250 prints per minute	Up to 250 prints per minute

## Intermittent mode:

Maximum Print Area (Width x Length)	2.1" (53mm) wide x 2.95" (75mm) long	4.3" (107mm) wide x 2.95" (75mm) long	2.1" (53mm) wide x 2.95" (75mm) long	1.3" (32mm) wide x 2.95" (75mm) long
Maximum Print Speed	31.5 in/sec (800mm/sec)	23.6 in/sec (600mm/sec)	29.5 in/sec (750mm/sec)	29.5 in/sec (750mm/sec)
Minimum Print Speed	0.4 in/sec (10mm/sec)	0.4 in/sec (10mm/sec)	1.6 in/sec (40mm/sec) full print quality; 0.4 in/sec (10mm/sec) draft mode print quality	1.6 in/sec (40mm/sec) full print quality; 0.4 in/sec (10mm/sec) draft mode print quality

Windows® is a registered trademark of Microsoft Corporation in the United States and/or other countries.

# Peace of mind comes as standard

Videojet Technologies is a world-leader in the product identification market, providing in-line printing, coding, and marking products, application specific fluids, and product LifeCycle Advantage™.

Our goal is to partner with our customers in the consumer packaged goods, pharmaceutical, and industrial goods industries to improve their productivity, to protect and grow their brands, and to stay ahead of industry trends and regulations. With our customer application experts and technology leadership in Continuous Inkjet (CIJ), Thermal Inkjet (TIJ), Laser Marking, Thermal Transfer Overprinting (TTO), case coding and labeling, and wide array printing, Videojet has more than 345,000 printers installed worldwide.

Our customers rely on Videojet products to print on over ten billion products daily. Customer sales, application, service and training support is provided by direct operations with over 4,000 team members in 26 countries worldwide. In addition, Videojet's distribution network includes more than 400 distributors and OEMs, serving 135 countries.

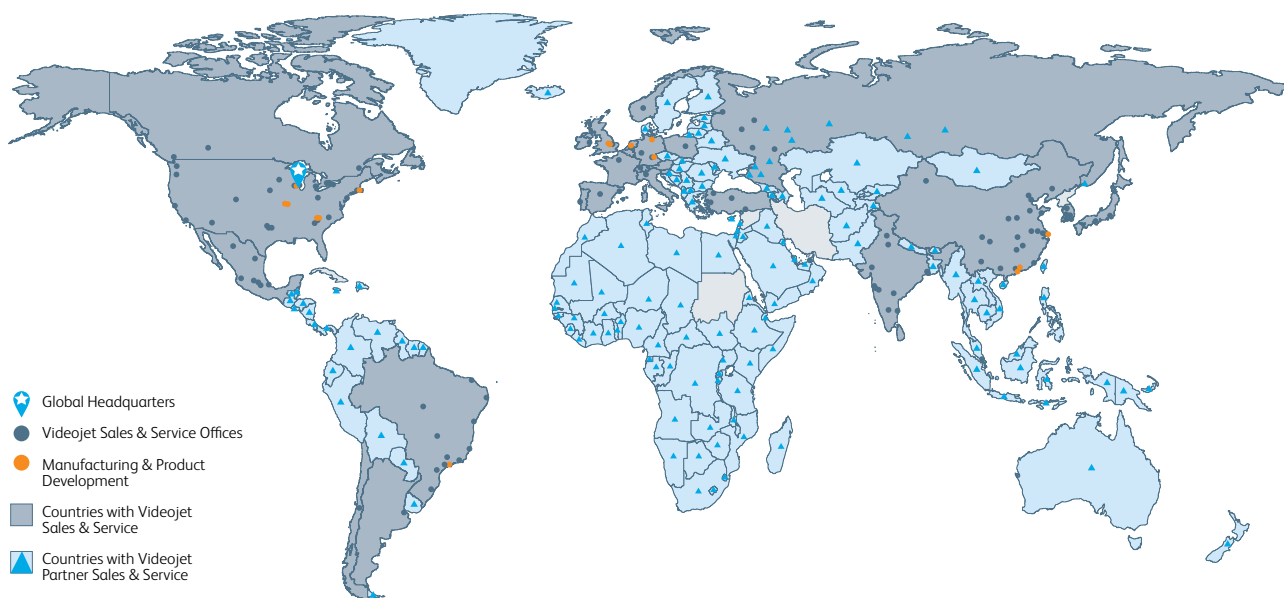

**New printer quote 866-871-3226**

Order supplies [shop.videojet.com](http://shop.videojet.com)  
Call **800-843-3610**  
Email [info@videojet.com](mailto:info@videojet.com)  
visit [www.videojet.com](http://www.videojet.com)

Videojet Technologies Inc.  
1500 Mittel Blvd. Wood Dale IL 60191 / USA

©2019 Videojet Technologies Inc. All rights reserved.  
Videojet Technologies Inc.'s policy is one of continued product improvement.  
We reserve the right to alter design and/or specifications without notice.

Part number SL00650  
br-6530-6330-us-0419  
Printed in U.S.A

